

INTRODUCING THE T-SLOT BLOCK

PATENTED WORKHOLDING

UNIQUE, VERSATILE, MODULAR

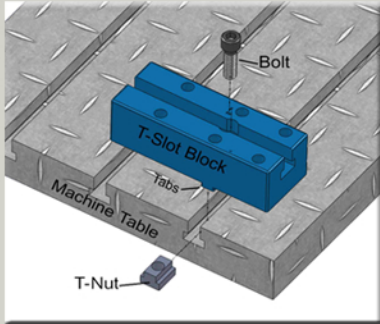

Installing the T-Slot Block is real fast and easy. The tabs on the T-Slot Block align to the machine table. Use bolt and T-Nut to attach T-Slot Block

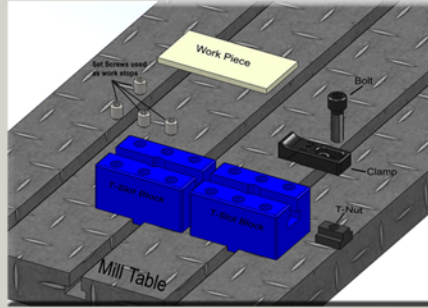

Installing parts on T-Slot Blocks is real fast and easy. Simply use any bolt, T-Nut, clamp, strap or what ever tool you have.

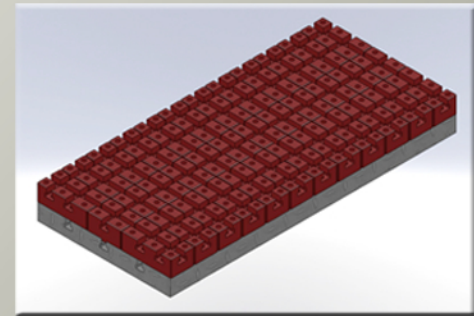

High density workholding

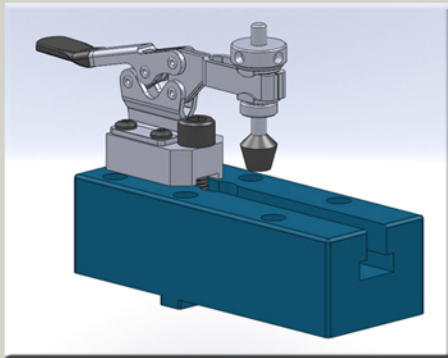

Dedicated fixtures,

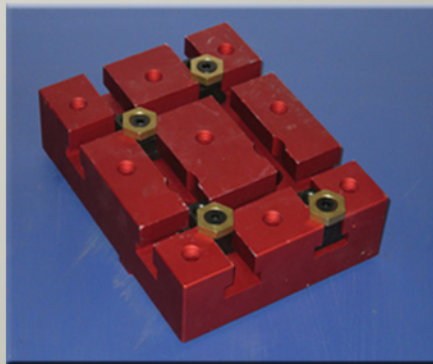

Setup stations for repeat work

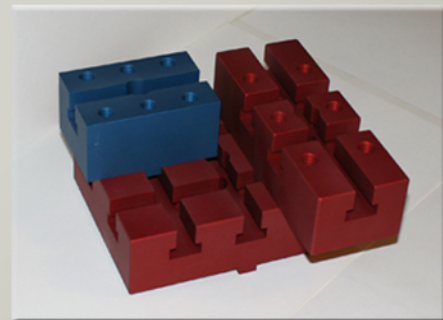
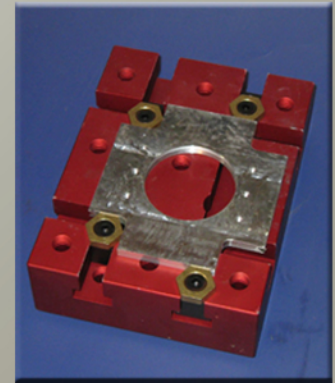

Stackable

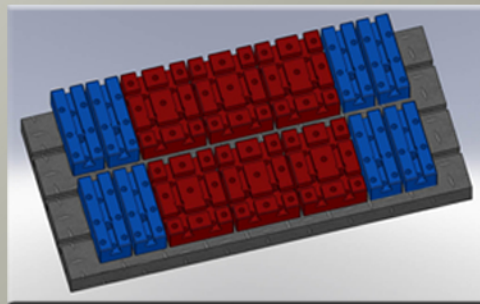

Modular, Configurable

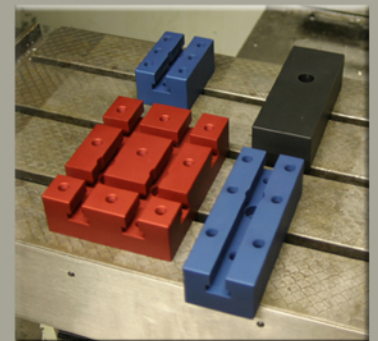

Order what you need, save money, be more productive.

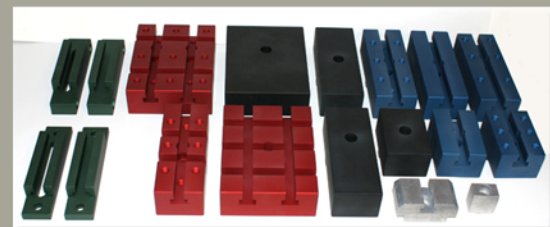

Tau Ceti Co.
P.O. Box 1101
Conroe, TX 77305

936-499-2304
sbarziza@consolidated.net

Kits of all types, large or small



MADE IN USA